



**GN-Schalen, Bleche, Roste  
vom Edelstahlspezialisten  
für Verpflegung und  
Grossküchentechnik.**



**GN 2/1**  
650 x 530 mm



Behälter ohne Griffe			
		Geschlossen	Gelocht
Tiefe	Inhalt	Bestell-Nr.	Bestell-Nr.
20 mm		01.3050.2H	01.3290.0H
40 mm	10,0 l	01.3051.2H	01.3290.1H
65 mm	17,0 l	01.3052.2H	01.3290.2H
100 mm	27,0 l	01.3053.2H	01.3291.2H
150 mm	41,0 l	01.3054.2H	01.3292.2H
200 mm	55,0 l	01.3055.2H	01.3293.2H



**GN 1/1**  
530 x 325 mm



Deckel	
Ausführung	Bestell-Nr.
mit Griffmulde	01.3164.2H
mit Dichtung	01.3225.2HD

Behälter ohne Griffe			
		Geschlossen	Gelocht
Tiefe	Inhalt	Bestell-Nr.	Bestell-Nr.
20 mm		01.3060.2H	01.3257.0H
40 mm	3,4 l	01.3061.2H	01.3257.1H
65 mm	7,0 l	01.3062.2H	01.3257.2H
100 mm	11,7 l	01.3063.2H	01.3258.2H
150 mm	18,4 l	01.3064.2H	01.3259.2H
200 mm	26,0 l	01.3065.2H	01.3260.2H



**GN 1/1**  
530 x 325 mm



Behälter mit versenkbaren Griffen			
		Geschlossen	Gelocht
Tiefe	Inhalt	Bestell-Nr.	Bestell-Nr.
65 mm	7,0 l	01.3062.2HF	01.3257.2HF
100 mm	11,7 l	01.3063.2HF	01.3258.2HF
150 mm	18,4 l	01.3064.2HF	01.3259.2HF
200 mm	26,0 l	01.3065.2HF	01.3260.2HF

**GN 2/3**  
325 x 352 mm



Behälter ohne Griffe			
		Geschlossen	Gelocht
Tiefe	Inhalt	Bestell-Nr.	Bestell-Nr.
20 mm		01.3120.2H	01.3294.0H
40 mm	2,4 l	01.3121.2H	01.3294.1H
65 mm	4,3 l	01.3122.2H	01.3294.2H
100 mm	7,4 l	01.3123.2H	01.3295.2H
150 mm	11,8 l	01.3124.2H	01.3296.2H
200 mm	15,3 l	01.3125.2H	01.3297.2H

Deckel	
Ausführung	Bestell-Nr.
mit Griffmulde	01.3169.2H
mit Dichtung	01.3227.2HD

**GN 2/3**  
325 x 352 mm





Behälter mit versenkbaren Griffen			
		Geschlossen	Gelocht
Tiefe	Inhalt	Bestell-Nr.	Bestell-Nr.
65 mm	4,3 l	01.3122.2HF	01.3294.2HF
100 mm	7,4 l	01.3123.2HF	01.3295.2HF
150 mm	11,8 l	01.3124.2HF	01.3296.2HF
200 mm	15,3 l	01.3125.2HF	01.3297.2HF



**GN 1/2**  
325 x 265 mm



Behälter ohne Griffe			
		Geschlossen	Gelocht
Tiefe	Inhalt	Bestell-Nr.	Bestell-Nr.
20 mm		01.3075.2H	01.3261.0H
40 mm	1,7 l	01.3076.2H	01.3261.1H
65 mm	3,3 l	01.3077.2H	01.3261.2H
100 mm	5,3 l	01.3078.2H	01.3262.2H
150 mm	8,4 l	01.3079.2H	01.3263.2H
200 mm	10,9 l	01.3080.2H	01.3264.2H

Deckel	
Ausführung	Bestell-Nr.
mit Griffmulde	01.3165.2H
mit Dichtung	01.3229.2HD

**GN 1/2**  
325 x 265 mm

Behälter mit versenkbaren Griffen			
		Geschlossen	Gelocht
Tiefe	Inhalt	Bestell-Nr.	Bestell-Nr.
65 mm	3,3 l	01.3077.2HF	01.3261.2HF
100 mm	5,3 l	01.3078.2HF	01.3262.2HF
150 mm	8,4 l	01.3079.2HF	01.3263.2HF
200 mm	10,9 l	01.3080.2HF	01.3264.2HF

**GN 1/3**  
325 x 176 mm



Behälter ohne Griffe			
		Geschlossen	Gelocht
Tiefe	Inhalt	Bestell-Nr.	Bestell-Nr.
20 mm		01.3135.2H	-
40 mm	1,0 l	01.3136.2H	01.3300.2H
65 mm	2,0 l	01.3137.2H	01.3301.2H
100 mm	3,3 l	01.3138.2H	01.3301.3H
150 mm	4,9 l	01.3139.2H	01.3301.4H
200 mm	6,6 l	01.3140.2H	01.3301.5H

Deckel	
Ausführung	Bestell-Nr.
mit Griffmulde	01.3170.2H
mit Dichtung	01.3231.2HD

**GN 1/3**  
325 x 176 mm





Behälter mit versenkbaren Griffen		
		Geschlossen
Tiefe	Inhalt	Bestell-Nr.
65 mm	2,0 l	01.3137.2HF
100 mm	3,3 l	01.3138.2HF
150 mm	4,9 l	01.3139.2HF
200 mm	6,6 l	01.3140.2HF

**GN 1/4**  
265 x 162 mm



Behälter ohne Griffe		
		Geschlossen
Tiefe	Inhalt	Bestell-Nr.
20 mm		01.3101.2H
65 mm	1,5 l	01.3102.2H
100 mm	2,3 l	01.3103.2H
150 mm	3,6 l	01.3104.2H
200 mm	5,0 l	01.3105.2H

Deckel	
Ausführung	Bestell-Nr.
mit Griffmulde	01.3167.2H
mit Dichtung	01.3233.2HD

**GN 1/4**  
265 x 162 mm





Behälter mit versenkbaren Griffen		
		Geschlossen
Tiefe	Inhalt	Bestell-Nr.
65 mm	1,5 l	01.3102.2HF
100 mm	2,3 l	01.3103.2HF
150 mm	3,6 l	01.3104.2HF
200 mm	5,0 l	01.3105.2HF



**GN 2/4**  
162 x 530 mm



Deckel	
Ausführung	Bestell-Nr.
mit Griffmulde	01.3184.2H

Behälter ohne Griffe		
		Geschlossen
Tiefe	Inhalt	Bestell-Nr.
20 mm		01.3090.2H
40 mm	1,7 l	01.3091.2H
65 mm	3,3 l	01.3092.2H
100 mm	5,3 l	01.3093.2H
150 mm	8,4 l	01.3094.2H



**GN 2/4**  
162 x 530 mm



Behälter mit versenkbaren Griffen		
		Geschlossen
Tiefe	Inhalt	Bestell-Nr.
65 mm	3,3 l	01.3092.2HF
100 mm	5,3 l	01.3093.2HF
150 mm	8,4 l	01.3094.2HF



**GN 1/6**  
162 x 176 mm

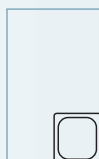

Deckel	
Ausführung	Bestell-Nr.
mit Griffmulde	01.3171.2H
mit Dichtung	01.3235.2HD

Behälter ohne Griffe		
		Geschlossen
Tiefe	Inhalt	Bestell-Nr.
65 mm	0,9 l	01.3150.2H
100 mm	1,4 l	01.3151.2H
150 mm	2,1 l	01.3152.2H
200 mm	2,8 l	01.3153.2H



**GN 1/6**  
162 x 176 mm

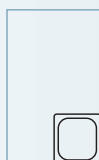

Behälter mit versenkbaren Griffen		
		Geschlossen
Tiefe	Inhalt	Bestell-Nr.
65 mm	0,9 l	01.3150.2HF
100 mm	1,4 l	01.3151.2HF
150 mm	2,1 l	01.3152.2HF
200 mm	2,8 l	01.3153.2HF



**GN 1/9**  
176 x 108 mm

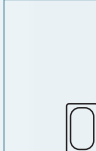

Deckel		Behälter ohne Griffe		
Ausführung	Bestell-Nr.	Tiefe	Inhalt	Geschlossen Bestell-Nr.
mit Griffmulde	01.3172.2H	65 mm	0,5 l	01.3162.2H
		100 mm	0,7 l	01.3163.2H



**Gastronormblech**  
Inox 18/10  
mit glattem Rand

Tiefe	Inhalt	Bestell-Nr.
<b>GN 2/1, 650 x 530 mm</b>		
20 mm	-	01.3050.2HB
<b>GN 1/1, 530 x 325 mm</b>		
20 mm	2,3 l	01.3060.2HB



**GN-Behälter gelocht**  
nicht zum Einsetzen

Behälter gelocht, ohne Griffe		
Tiefe	Inhalt	Bestell-Nr.
100 mm	-	01.3291.2H
150 mm	-	01.3292.2H
200 mm	-	01.3293.2H

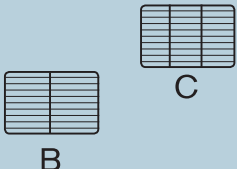

**Gastronormrost**  
Inox 18/10  
Schwere Ausführung

Grösse	Rost	Bestell-Nr.
GN 2/1	C	310014021
GN 1/1	B	310014023

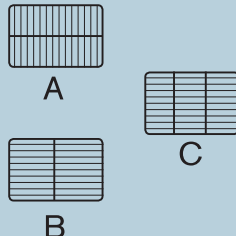

**Gastronormrost**  
Inox 18/10  
Leichte Ausführung

Grösse	Rost	Bestell-Nr.
GN 2/1	C	310550266
GN 1/1	B	310550267
GN 2/3	A	310014011



**Einlegeboden gelocht**

Grösse	Bestell-Nr.
GN 2/1	01.3252.1HB
GN 1/1	01.3252.2HB
GN 1/2	01.3253.2HB



**GN-Stege**  
für Behälter-Zusammenstellung

Grösse	Bestell-Nr.
GN 1/1 - 530 mm	01.3251.2H
GN 1/2 - 325 mm	01.3252.2H





## Polycarbonat-Behälter zur Aufbewahrung von Speisen und Nahrungsmitteln.



Lebensmittelecht, geruchs- und geschmacksneutral, schlagfest, temperaturbeständig bis -40° C.



Polycarbonatdeckel auf allen GN-Behältern ohne Griffe einsetzbar.

Grösse	Tiefe	Inhalt	Bestell-Nr.
<b>GN 2/1, 650 x 325 mm</b>			
	-	-	-
	-	-	-
	-	-	-
	200 mm	-	3200130653P
	Deckel		3200130654P
Einlegeboden		3200130655P	
<b>GN 1/1, 325 x 530 mm</b>			
	65 mm	9,0 l	3200130622P
	100 mm	14,0 l	3200130632P
	150 mm	21,0 l	3200130642P
	200 mm	28,0 l	3200130652P
	Deckel		3200131642P
	Einlegeboden		3200132522P
<b>GN 1/2, 325 x 265 mm</b>			
	65 mm	4,0 l	3200130772P
	100 mm	6,5 l	3200130782P
	150 mm	9,5 l	3200130792P
	200 mm	12,5 l	3200130802P
	Deckel		3200131652P
	Einlegeboden		3200132532P
<b>GN 1/3, 325 x 176 mm</b>			
	65 mm	2,5 l	3200133052P
	100 mm	4,0 l	3200131382P
	150 mm	5,7 l	3200131392P
	200 mm	7,8 l	3200133042P
	Deckel		3200131702P
	-	-	-

Nicht zum Garen geeignet.

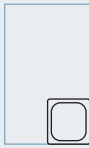
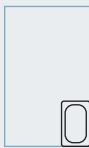
Grösse	Tiefe	Inhalt	Bestell-Nr.
<b>GN 1/4, 162 x 265 mm</b>			
	65 mm	1,8 l	3200133032P
	100 mm	2,8 l	3200131032P
	150 mm	4,0 l	3200131042P
	200 mm	5,0 l	3200133022P
	Deckel		3200131672P
	-	-	-
<b>GN 1/6, 162 x 176 mm</b>			
	65 mm	1,0 l	3200133062P
	100 mm	1,6 l	3200131512P
	150 mm	2,4 l	3200131522P
	200 mm	2,8 l	3200133033P
	Deckel		3200131712P
	-	-	-
<b>GN 1/9, 108 x 176 mm</b>			
	65 mm	0,6 l	3200133082P
	100 mm	1,0 l	3200133072P
	-	-	-
	-	-	-
	Deckel		3200133092P
	-	-	-

## Polypropylen-Behälter zur Aufbewahrung von Speisen und Nahrungsmitteln.



Hygienisch, absolut geruchs- und geschmacksneutral, bruchfest und schlagzäh, temperaturbeständig -30°C bis + 99°C.



Schwappsicherer Clipdeckel.

**Nicht zum Garen geeignet.**

Grösse	Tiefe	Inhalt	Bestell-Nr.
<b>GN 1/1, 325 x 530 mm</b>			
	65 mm	9,0 l	PR11065
	100 mm	14,0 l	PR11100
	150 mm	21,0 l	PR11150
	200 mm	28,0 l	PR11200
	Deckel weiss		PRC11
	Einlegeboden gelocht		PRFFF11
<b>GN 1/2, 325 x 265 mm</b>			
	65 mm	4,0 l	PR12065
	100 mm	6,5 l	PR12100
	150 mm	9,5 l	PR12150
	200 mm	12,5 l	PR12200
	Deckel weiss		PRC12
	Einlegeboden gelocht		PRFFF12
<b>GN 1/3, 325 x 176 mm</b>			
	65 mm	2,5 l	PR13065
	100 mm	4,0 l	PR13100
	150 mm	5,7 l	PR13150
	200 mm	7,8 l	PR13200
	Deckel weiss		PRC13
	-		-

Grösse	Tiefe	Inhalt	Bestell-Nr.
<b>GN 1/4, 162 x 265 mm</b>			
	65 mm	1,8 l	PR14065
	100 mm	2,8 l	PR14100
	150 mm	4,0 l	PR14150
	200 mm	5,0 l	PR14200
	Deckel weiss		PRC14
	-		-
<b>GN 1/6, 162 x 176 mm</b>			
	65 mm	1,0 l	PR16065
	100 mm	1,6 l	PR16100
	150 mm	2,4 l	PR16150
	200 mm	2,8 l	PR16200
	Deckel weiss		PRC16
	-		-
<b>GN 1/9, 108 x 176 mm</b>			
	65 mm	0,6 l	PR19065
	100 mm	1,0 l	PR19100
	-	-	-
	-	-	-
	Deckel weiss		PRC19
	-		-



Porzellan-Behälter  
zur Präsentation  
und Zubereitung  
von Speisen



**GN 1/1**  
530 x 325 mm



Behälter ohne Griffe

Tiefe	Inhalt	Bestell-Nr.
20 mm	-	8001.55510
65 mm	-	8001.55511

Behälter für Induktion

Tiefe	Inhalt	Bestell-Nr.
65 mm	-	8001.55900

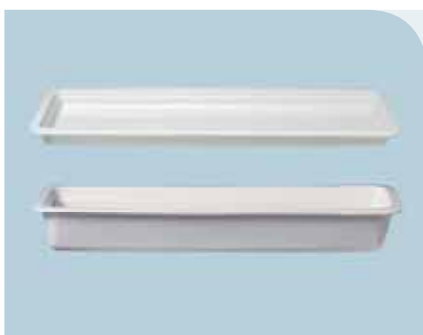

**GN 2/4**  
162 x 530 mm

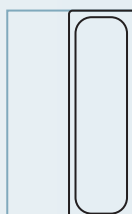

Behälter ohne Griffe

Tiefe	Inhalt	Bestell-Nr.
20 mm	-	8001.55522
65 mm	-	8001.55708

Behälter für Induktion

Tiefe	Inhalt	Bestell-Nr.
65 mm	-	8001.55904

**GN 2/3**  
325 x 352 mm



Behälter ohne Griffe		
Tiefe	Inhalt	Bestell-Nr.
20 mm	-	8001.55523
65 mm	-	8001.55518
Behälter für Induktion		
Tiefe	Inhalt	Bestell-Nr.
65 mm	-	8001.55902

**GN 1/2**  
325 x 265 mm



Behälter ohne Griffe		
Tiefe	Inhalt	Bestell-Nr.
20 mm	-	8001.55524
65 mm	-	8001.55512
Behälter für Induktion		
Tiefe	Inhalt	Bestell-Nr.
65 mm	-	8001.55901

**GN 1/3**  
325 x 176 mm



Behälter ohne Griffe		
Tiefe	Inhalt	Bestell-Nr.
20 mm	-	8001.55525
65 mm	-	8001.55519
Behälter für Induktion		
Tiefe	Inhalt	Bestell-Nr.
65 mm	-	8001.55903

**GN 1/4**  
265 x 162 mm



Behälter ohne Griffe		
Tiefe	Inhalt	Bestell-Nr.
20 mm	-	8001.55526
65 mm	-	8001.55520

**GN 1/6**  
162 x 176 mm



Behälter ohne Griffe		
Tiefe	Inhalt	Bestell-Nr.
20 mm	-	8001.55527
65 mm	-	8001.55521